

88.0%

4kV 6kV

IP67
SELV

EBV-048SxxxSVF

48W IP67

176-305Vac

	(1)		(2)	(3)	220Vac	
24 V	176 ~ 305 Vac 190 ~ 250 Vdc	0 ~ 2.0 A	48 W	85.0%	0.96	EBV-048S024SVF
36 V	176 ~ 305 Vac 190 ~ 250 Vdc	0 ~ 1.34 A	48 W	86.5%	0.96	EBV-048S036SVF
48 V	176 ~ 305 Vac 190 ~ 250 Vdc	0 ~ 1.0 A	48 W	88.0%	0.96	EBV-048S048SVF

- 1 CCC 220/230/240Vac; CCC 200-240Vac
- 2 90-305Vac 90-176Vac " "
- 3 220Vac 100% " "

	176 Vac	-	305 Vac	190 ~ 250 Vdc
	47 Hz	-	63 Hz	
	-	-	0.70 mA	IEC60598-1; 240Vac/60Hz
	-	-	0.3 A	220Vac 100%

I ² t	-	-	0.029 A ² s	220Vac 25 10%Ipk-10%Ipk = 1.72 μs
	0.9	-	-	220-240Vac, 50-60Hz, 70%-100% 33.6~ 48W
	-	-	12%	

	-5%Vo	-	5%Vo	100%
(pk-avg) EBV-048S024SVF EBV-048S036SVF EBV-048S048SVF	- - -	- - -	2.0 V 2.5 V 2.5 V	0% - 100% 20MHz 0.1μF 47μF
	-	-	5%Vo	100%
	-	-	±1%	100%
	-	-	±3%	
	-	-	0.5 s	220Vac 100%
	-	-	8%Vo	/ 1 A/μs 25% ~ 100%
	-	-	10 ms	
	-	0.03%/ C	-	= 0 C~Tc

25 C

@220Vac: EBV-048S024SVF EBV-048S036SVF EBV-048S048SVF	83.0% 84.5% 86.0%	85.0% 86.5% 88.0%	- - -	100% 25°
	-	871,000 Hours	-	220 Vac 25 80% (MIL- HDBK-217F)
	-	104,000 Hours	-	220 Vac 80% 70

	-40°C	-	+90°C	
	-40°C	-	+75 C	5 10% RH to 100%RH
	-40°C	-	+85°C	5%RH to 100%RH
(L × W × H)	5.28 x 1.57 x 0.98			6.1 x 1.57 x 0.98
(L × W × H)	134 x 40.0 x 25.0			155 x 40.0 x 25.0
	-	340 g	-	

25 C

CE	EN 61347-1, EN61347-2-13
CB	IEC 61347-1, IEC 61347-2-13
CCC	GB 19510.1, GB 19510.14
KS	KS C 7655
EMI	
EN 55015/GB 17743 ⁽¹⁾	Conducted emission Test & Radiated emission Test
EN 61000-3-2/GB 17625.1	Harmonic current emissions
EN 61000-3-3	Voltage fluctuations & flicker
EMS	
EN 61000-4-2	Electrostatic Discharge (ESD): 8 kV air discharge, 4 kV contact discharge
EN 61000-4-3	Radio-Frequency Electromagnetic Field Susceptibility Test-RS
EN 61000-4-4	Electrical Fast Transient / Burst-EFT
EN 61000-4-5	Surge Immunity Test: AC Power Line: Differential Mode 4 kV, Common Mode 6 kV
EN 61000-4-6	Conducted Radio Frequency Disturbances Test-CS
EN 61000-4-8	Power Frequency Magnetic Field Test
EN 61000-4-11	Voltage Dips

EMS	
EN 61547	Electromagnetic Immunity Requirements Applies To Lighting Equipment

1 EMI

() EMI

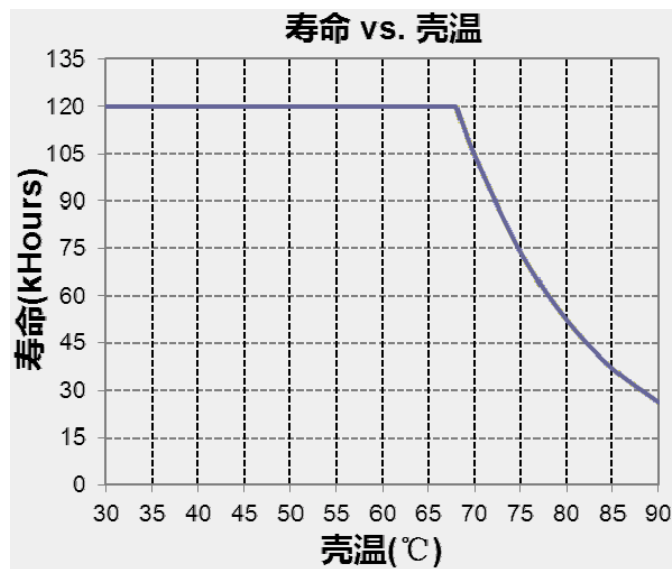
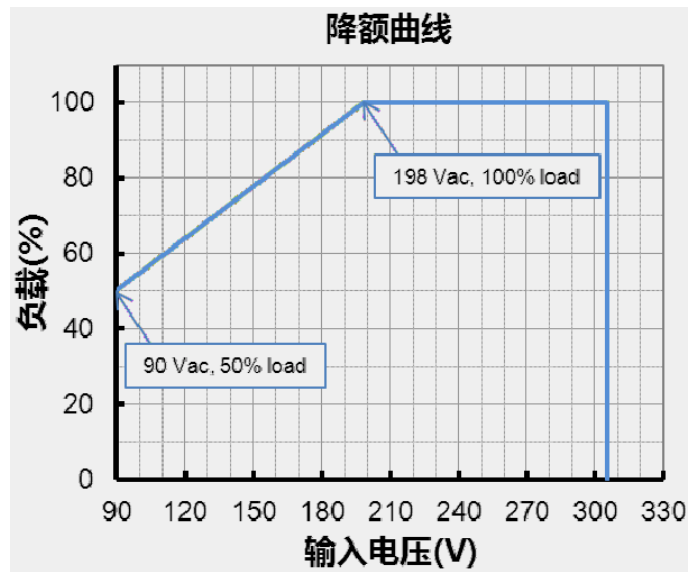

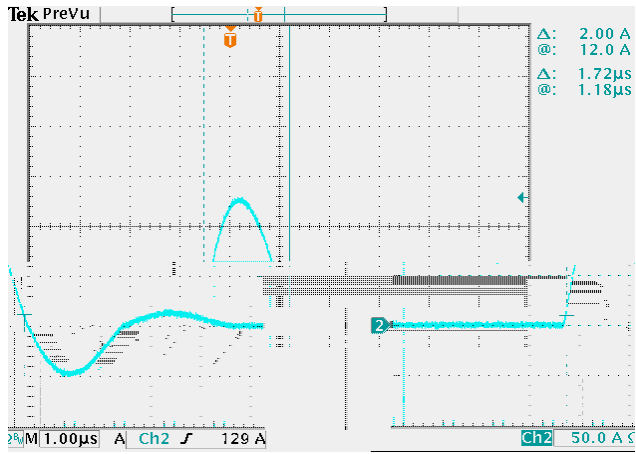

EBV-048S024SVF
效率 vs. 输出电流

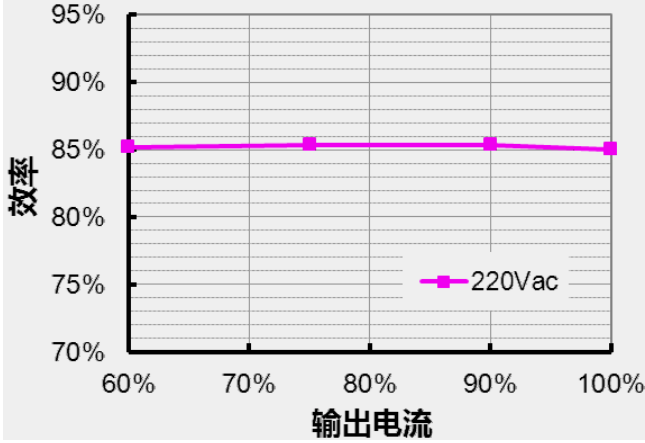

EBV-048S036SVF
效率 vs. 输出电流

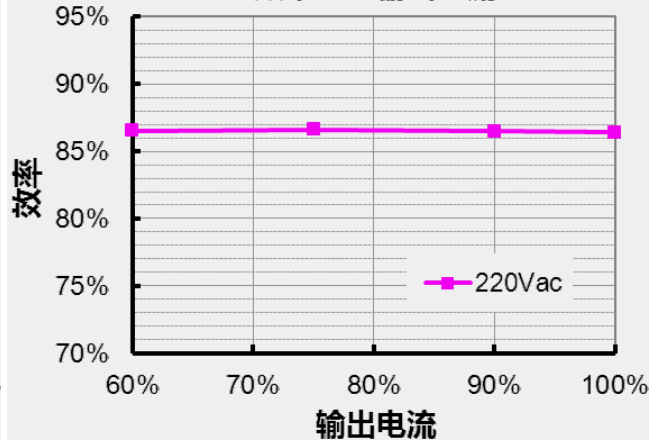

EBV-048S048SVF



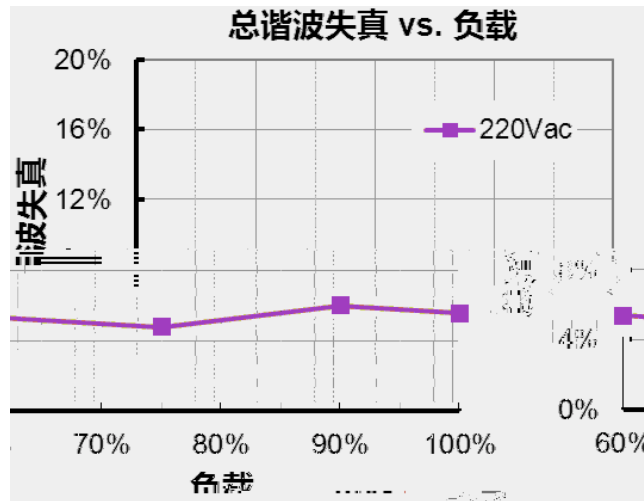
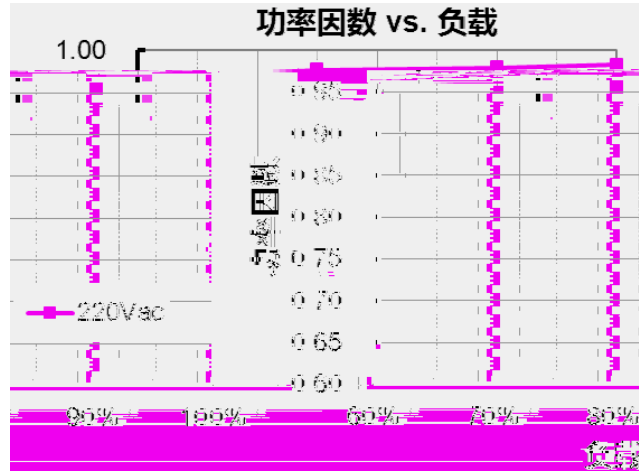

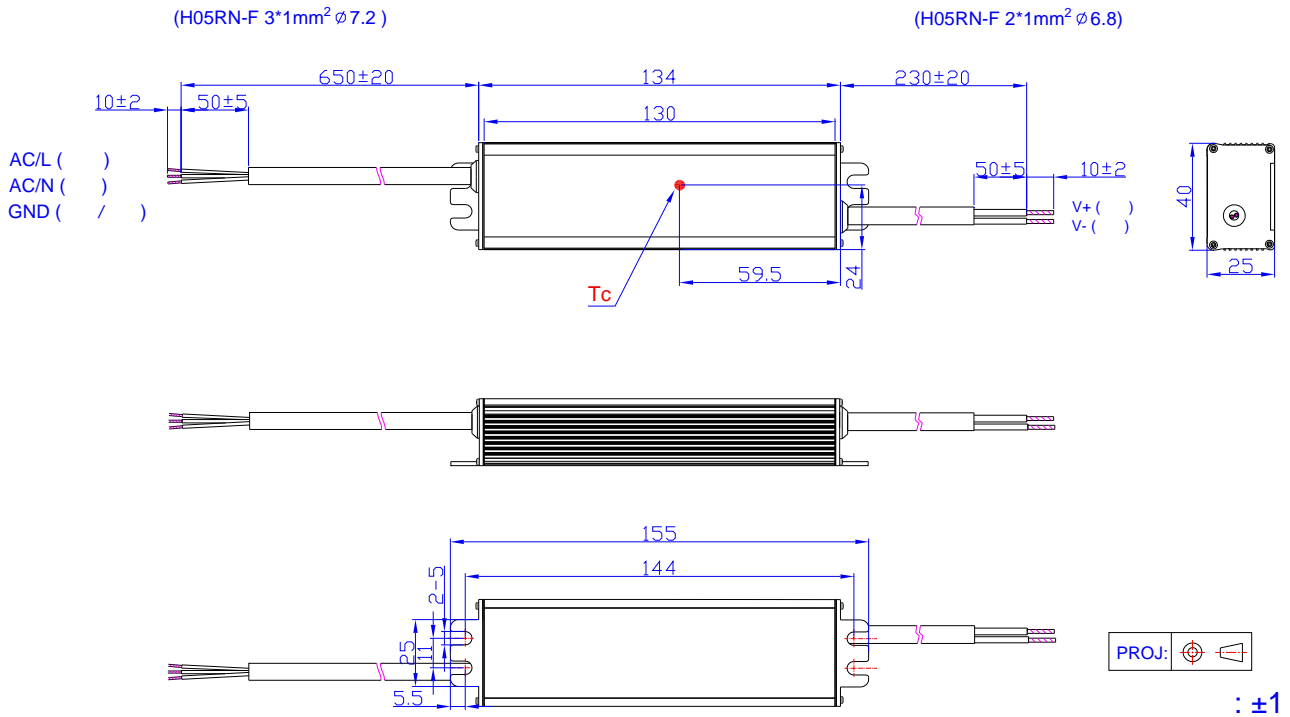

RoHS

RoHS

2011/65/EU

EU

2015/863

2019-07-30	A		/	/
2019-08-09	B		1 200-240Vac	1 CCC 220/230/240Vac; CCC 200-240Vac
			/	